

Cobra Medical Heavy Pattern Basin Mixer WT 15mm CP



Range: Medical Heavy Pattern

Description: Heavy Pattern Medical elbow-action wall type mixer with progressive control eco 4.5l/min flow regulators. Care & Maintenance - Ensure your product does not come into contact with any lubricants during installation. Chrome plated, matte black and any colour finishes should be wipped with warm soapy water and a soft cloth or sponge. Rinse, then dry and buff with a dry soft cloth. Under no circumstances must any detergents containing hydrochloric acids or abrasives including cream cleansers be used. Do not use abrasive cleaning materials such as scourers. Should your product have an aerator at the water outlet, it should be checked and cleaned regularly.

Product Code: 507/HP

ERP Code: 1033740000

Barcode: 6002194156871

Product Features: Cobra PureShine, Cobra EcoMind, Cobra DefenZR, Cobra TeamAssist, Cobra LowPressure, 20 Year Warranty

Dimensions: (l) 270mm x (w) 130mm x (h) 160mm

Package Weight: 2.9

Product Images

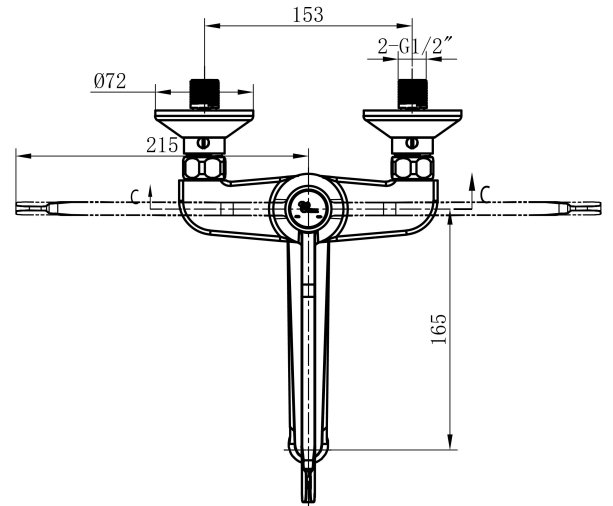

Flow Chart

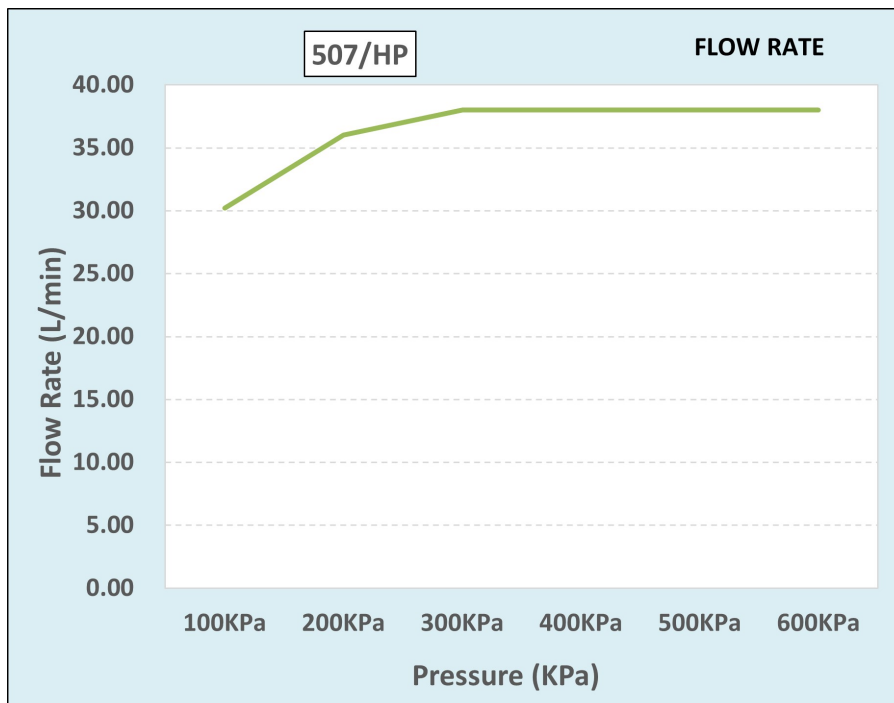

MOT



Cobra TeamAssist



Cobra EcoMind



Cobra PureShine



Cobra DefenZR



Cobra LowPressure



20 Year Warranty