



COBRA

HERE FOR YOU



COBRA

SAFE CRIMP™

**INSTALLATION
CONFIDENCE
MULTI-PRESS
SYSTEM**



2023

PART OF **LIXIL**

Advantages of Cobra Safe Crimp pipes

- Corrosion-resistant
- Light in weight and flexible
- Barrier to the permeation of oxygen and light
- Smooth inner wall ensures low pressure loss
- Ideal for plumbing solutions

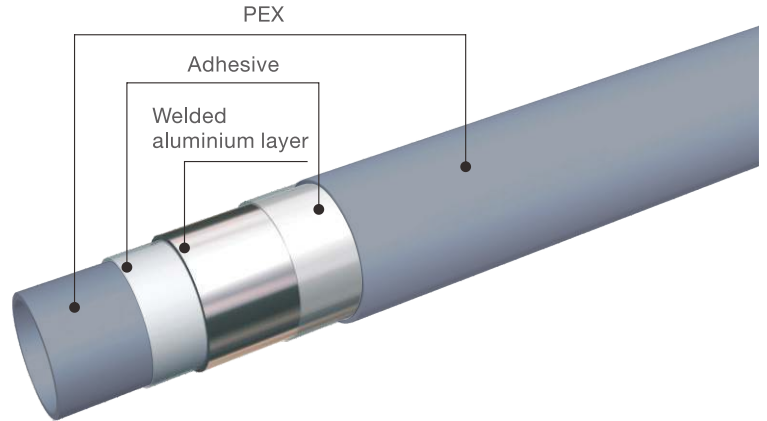

Technical Parameters

TYPE	PEX-AL-PEX
Material	Cross-linked Polyethylene
Roughness(mm)	0.0007
Density (g/cm ³)	0.926-0.959
Modulus of elasticity(MPa)	7200
Thermal conductivity (w/mK)	0.45
Coefficient of thermal expansion (mm/mK)	0.025
Application	Hot and cold potable water system, Underfloor heating system
Working Temperature	-40°C~ +95°C
Maximum working pressure	10 bar

Certificate



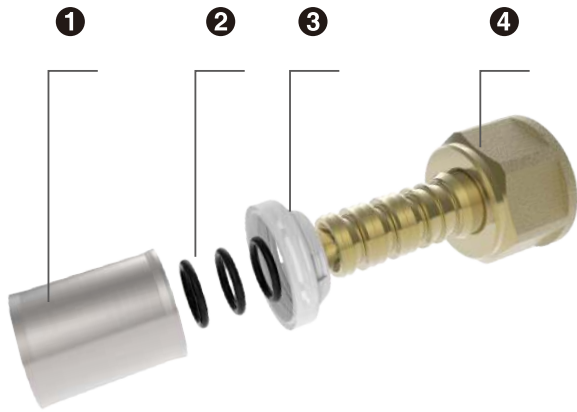

- 1 Sleeve**
Material: SUS304

- 2 O-ring**
Material: EPDM

- 3 Baffle**
Material: PE

- 4 Fitting main body**
Brass CW602N

Technical Data

Maximum Pressure & Temperature:
1.5MPa, -20 ~120°C

Advantages

Leakage indication,
Prevent risk of leakage

Three O-rings, Better
sealing performance

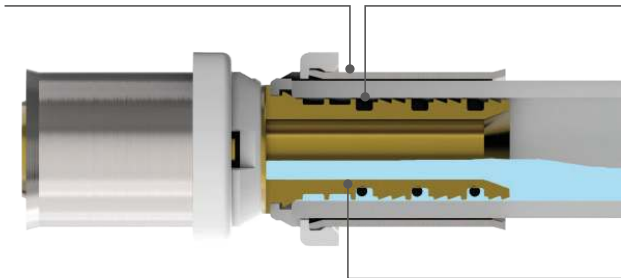

Runcinate shape,
Improves the tensile
strength by 1.5 times

Cobra-Safe sealing performance with 3 O-rings for ultimate peace of mind. Early leakage detection inspection slot, in case of incomplete pressing. Made from DZR brass. Nickle plated for enhanced corrosion resistance. Compatible crimping profiles: U / TH / H / RFZ

Pressing Tool Instruction:

To avoid leakage due to incorrect installation, each pressing tool should be placed at the right position before pressing. Here are the correct pressing tool positions.

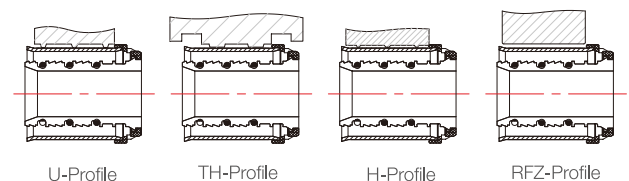

Straight Coupling



Description	Codes
Coupler equal straight 16mmx16mm Order QTY:.....	CR-1-16 FCRIMO38-8HTO1
Coupler equal straight 20mmx20mm Order QTY:.....	CR-1-20 FCRIMO46-8HTO1
Coupler equal straight 25mmx25mm Order QTY:.....	CR-1-25 FCRIMO58-8HTO1
Coupler equal straight 32mmx32mm Order QTY:.....	CR-1-32 FCRIMO70-8HTO1

Coupler Male Straight



Description	Codes
Coupler male straight 20mmx1/2inch Order QTY:.....	CR-2-20X1/2 FCRIMO43-8HTO1
Coupler male straight 20mmx3/4inch Order QTY:.....	CR-2-20X3/4 FCRIMO49-8HTO1
Coupler male straight 25mmx1/2inch Order QTY:.....	CR-2-25X1/2 FCRIMO53-8HTO1
Coupler male straight 25mmx1inch Order QTY:.....	CR-2-25X1 FCRIMO52-8HTO1
Coupler male straight 25mmx3/4inch Order QTY:.....	CR-2-25X3/4 FCRIMO61-8HTO1
Coupler male straight 32mmx1inch Order QTY:.....	CR-2-32X1 FCRIMO64-8HTO1
Coupler male straight 32mmx3/4inch Order QTY:.....	CR-2-32X3/4 FCRIMO73-8HTO1
Coupler male straight 16mmx1/2inch Order QTY:.....	CR-2-16X1/2 FCRIMO35-8HTO1
Coupler male straight 16mmx3/4inch Order QTY:.....	CR-2-16X3/4 FCRIMO41-8HTO1

Coupler Female Straight



Description	Codes
Coupler female straight 16mmx1/2inch Order QTY:.....	CR-3-16X1/2 FCRIMO36-8HTO1
Coupler female straight 16mmx3/4inch Order QTY:.....	CR-3-16X3/4 FCRIMO42-8HTO1
Coupler female straight 20mmx1/2inch Order QTY:.....	CR-3-20X1/2 FCRIMO44-8HTO1
Coupler female straight 20mmx3/4inch Order QTY:.....	CR-3-20X3/4 FCRIMO50-8HTO1
Coupler female straight 25mmx1/2inch Order QTY:.....	CR-3-25X1/2 FCRIMO54-8HTO1
Coupler female straight 25mmx1inch Order QTY:.....	CR-3-25X1 FCRIMO57-8HTO1
Coupler female straight 25mmx3/4inch Order QTY:.....	CR-3-25X3/4 FCRIMO62-8HTO1
Coupler female straight 32mmx1inch Order QTY:.....	CR-3-32X1 FCRIMO67-8HTO1
Coupler female straight 32mmx3/4inch Order QTY:.....	CR-3-32X3/4 FCRIMO74-8HTO1

Adaptor Compression Copper



Description	Codes
Adaptor compression copper 16mmx15Cu2 Order QTY:.....	CR-5-16X15 FCRIMO39-8HTO1
Adaptor compression copper 20mmx22Cu2 Order QTY:.....	CR-5-20X22 FCRIMO47-8HTO1
Adaptor compression copper 25mmx22Cu2 Order QTY:.....	CR-5-25X22 FCRIMO59-8HTO1
Adaptor compression copper 32mmx28Cu2 Order QTY:.....	CR-5-32X28 FCRIMO71-8HTO1

Coupler Demountable Female



Description	Codes
Coupler demountable female 16mmx1/2inch Order QTY:.....	CR-3D-16X1/2 FCRIMO37-8HTO1
Coupler demountable female 20mmx3/4inch Order QTY:.....	CR-3D-20X3/4 FCRIMO51-8HTO1
Coupler demountable female 25mmx3/4inch Order QTY:.....	CR-3D-25X3/4 FCRIMO63-8HTO1
Coupler demountable female 32mmx1inch Order QTY:.....	CR-3D-32X1 FCRIMO68-8HTO1

Coupler Straight Multi-Welded Copper



Description	Codes
Coupler straight multi-welded copper 16x15CuF Order QTY:.....	CR-16-16X15 FCRIMO40-8HTO1
Coupler straight multi-welded copper 20x22CuF Order QTY:.....	CR-16-20X22 FCRIMO48-8HTO1
Coupler straight multi-welded copper 25x22CuF Order QTY:.....	CR-16-25X22 FCRIMO60-8HTO1
Coupler straight multi-welded copper 32x28CuF Order QTY:.....	CR-16-32X28 FCRIMO72-8HTO1

Equal Elbow



Description	Codes
Elbow equal elbow 16mmx16mm Order QTY:.....	CR-4-16 FCRIMO12-8HTO1
Elbow equal elbow 20mmx20mm Order QTY:.....	CR-4-20 FCRIMO19-8HTO1
Elbow equal elbow 25mmx25mm Order QTY:.....	CR-4-25 FCRIMO27-8HTO1
Elbow equal elbow 32mmx32mm Order QTY:.....	CR-4-32 FCRIMO34-8HTO1

Coupler Unequal Straight



Description	Codes
Coupler unequal straight 20mmx16mm Order QTY:.....	CR-1R-20X16 FCRIMO45-8HTO1
Coupler unequal straight 25mmx16mm Order QTY:.....	CR-1R-25X16 FCRIMO55-8HTO1
Coupler unequal straight 25mmx20mm Order QTY:.....	CR-1R-25X20 FCRIMO56-8HTO1
Coupler unequal straight 32mmx16mm Order QTY:.....	CR-1R-32X16 FCRIMO65-8HTO1
Coupler unequal straight 32mmx20mm Order QTY:.....	CR-1R-32X20 FCRIMO66-8HTO1
Coupler unequal straight 32mmx25mm Order QTY:.....	CR-1R-32X25 FCRIMO69-8HTO1

Elbow Male



Description	Codes
Elbow male 16mmx1/2inch Order QTY:.....	CR-8-16X1/2 FCRIMO09-8HTO1
Elbow male 16mmx3/4inch Order QTY:.....	CR-8-16X3/4 FCRIMO13-8HTO1
Elbow male 20mmx1/2inch Order QTY:.....	CR-8-20X1/2 FCRIMO15-8HTO1
Elbow male 20mmx3/4inch Order QTY:.....	CR-8-20X3/4 FCRIMO20-8HTO1
Elbow male 25mmx1/2inch Order QTY:.....	CR-8-25X1/2 FCRIMO23-8HTO1
Elbow male 25mmx3/4inch Order QTY:.....	CR-8-25X3/4 FCRIMO28-8HTO1
Elbow male 32mmx1inch Order QTY:.....	CR-8-32X1 FCRIMO31-8HTO1

End Cap



Description	Codes
End cap 16mm Order QTY:.....	CR-23-16 FCRIMO05-8HTO1
End cap 20mm Order QTY:.....	CR-23-20 FCRIMO06-8HTO1
End cap 25mm Order QTY:.....	CR-23-25 FCRIMO07-8HTO1
End cap 32mm Order QTY:.....	CR-23-32 FCRIMO08-8HTO1

Elbow female



Description	Codes
Elbow female 16mmx1/2inch Order QTY:.....	CR-10-16X1/2 FCRIMO10-8HTO1
Elbow female 16mmx3/4inch Order QTY:.....	CR-10-16X3/4 FCRIMO14-8HTO1
Elbow female 20mmx1/2inch Order QTY:.....	CR-10-20X1/2 FCRIMO16-8HTO1
Elbow female 20mmx3/4inch Order QTY:.....	CR-10-20X3/4 FCRIMO21-8HTO1
Elbow female 25mmx1/2inch Order QTY:.....	CR-10-25X1/2 FCRIMO24-8HTO1
Elbow female 25mmx3/4inch Order QTY:.....	CR-10-25X3/4 FCRIMO29-8HTO1
Elbow female 32mmx1inch Order QTY:.....	CR-10-32X1 FCRIMO33-8HTO1

Elbow Reducing



Description	Codes
Elbow reducing 20mmx16mm Order QTY:.....	CR-4R-20X16 FCRIM018-8HT01
Elbow reducing 25mmx16mm Order QTY:.....	CR-4R-25X16 FCRIM025-8HT01
Elbow reducing 25mmx20mm Order QTY:.....	CR-4R-25X20 FCRIM026-8HT01
Elbow reducing 32mmx20mm Order QTY:.....	CR-4R32X20 FCRIM032-8HT01

Tee Female



Description	Codes
Tee female 16mmx1/2inchx16mm Order QTY:.....	CR-17-16X1/2X16 FCRIM075-8HT01
Tee female 20mmx1/2inchx20mm Order QTY:.....	CR-17-20X1/2X20 FCRIM079-8HT01
Tee female 25mmx1/2inchx25mm Order QTY:.....	CR-17-25X1/2X25 FCRIM083-8HT01
Tee female 25mmx3/4inchx25mm Order QTY:.....	CR-17-25X3/4X25 FCRIM087-8HT01
Tee female 32mmx1inchx32mm Order QTY:.....	CR-17-32X1X32 FCRIM090-8HT01
Tee female 32mmx3/4inchx32mm Order QTY:.....	CR-17-32X3/4X32 FCRIM093-8HT01

Elbow Wall Plated Female



Description	Codes
Elbow wall plated female 16mmx1/2inch Order QTY:.....	CR-33-16X1/2 FCRIM011-8HT01
Elbow wall plated female 20mmx1/2inch Order QTY:.....	CR-33-20X1/2 FCRIM017-8HT01
Elbow wall plated female 20mmx3/4inch Order QTY:.....	CR-33-20X3/4 FCRIM022-8HT01
Elbow wall plated female 25mmx3/4inch Order QTY:.....	CR-33-25X3/4 FCRIM030-8HT01

Tee Reducing



Description	Codes
Tee reducing 16mmx25mmx16mm Order QTY:.....	CR-279-16X25X16 FCRIM078-8HT01
Tee reducing 20mmx16mmx20mm Order QTY:.....	CR-279-20X16X20 FCRIM081-8HT01
Tee reducing 25mmx16mmx25mm Order QTY:.....	CR-279-25X16X25 FCRIM084-8HT01
Tee reducing 25mmx20mmx25mm Order QTY:.....	CR-279-25X20X25 FCRIM085-8HT01
Tee reducing 32mmx16mmx32mm Order QTY:.....	CR-279-32X16X32 FCRIM088-8HT01
Tee reducing 32mmx20mmx32mm Order QTY:.....	CR-279-32X20X32 FCRIM089-8HT01
Tee reducing 32mmx25mmx32mm Order QTY:.....	CR-279-32X25X32 FCRIM091-8HT01

Tee Equal



Description	Codes
Tee equal 16mmx16mmx16mm Order QTY:.....	CR-12-16 FCRIM077-8HT01
Tee equal 20mmx20mmx20mm Order QTY:.....	CR-12-20 FCRIM082-8HT01
Tee equal 25mmx25mmx25mm Order QTY:.....	CR-12-25 FCRIM086-8HT01
Tee equal 32mmx32mmx32mm Order QTY:.....	CR-12-32 FCRIM092-8HT01

Tee Male



Description	Codes
Tee male 16mmx1/2inchx16mm Order QTY:.....	CR-15-16X1/2X16 FCRIM076-8HT01
Tee male 20mmx1/2inchx20mm Order QTY:.....	CR-15-20X1/2X20 FCRIM080-8HT01

Crimp Multilayer Pipe



Description	Codes
Crimp Multilayer Pipe 16-200 Order QTY:.....	CR-MLP-16X200 FCRIM001-8HT01
Crimp Multilayer Pipe 20-200 Order QTY:.....	CR-MLP-20X200 FCRIM002-8HT01
Crimp Multilayer Pipe 25-100 Order QTY:.....	CR-MLP-25X100 FCRIM003-8HT01
Crimp Multilayer Pipe 32-50 Order QTY:.....	CR-MLP-32X50 FCRIM004-8HT01

Holderbat Close Aluminium



Description	Codes
Holderbat close aluminium (white) 16mm Order QTY:.....	CR-H/BATCLOSE-16 FCRIM094-8HT01
Holderbat close aluminium (white) 20mm Order QTY:.....	CR-H/BATCLOSE-20 FCRIM095-8HT01
Holderbat close aluminium (white) 25mm Order QTY:.....	CR-H/BATCLOSE-25 FCRIM096-8HT01
Holderbat close aluminium (white) 32mm Order QTY:.....	CR-H/BATCLOSE-32 FCRIM097-8HT01

Holderbat Open Aluminium



Description	Codes
Holderbat open aluminium (white) 16mm Order QTY:.....	CR-H/BATOPEN-16 FCRIM098-8HT01
Holderbat open aluminium (white) 20mm Order QTY:.....	CR-H/BATOPEN-20 FCRIM099-8HT01
Holderbat open aluminium (white) 25mm Order QTY:.....	CR-H/BATOPEN-25 FCRIM100-8HT01
Holderbat open aluminium (white) 32mm Order QTY:.....	CR-H/BATOPEN-32 FCRIM101-8HT01

Reamer Plastic/Metal Reamer



Description	Codes
Reamer plastic/metal reamer (16/20/25) Order QTY:.....	CR-REAMER-SM FCRIM104-8HT01
Reamer plastic/metal reamer (20/25/32) Order QTY:.....	CR-REAMER-LG FCRIM105-8HT01

Pipe Cutter



Description	Codes
Pipe cutter 32mm Order QTY:.....	CR-CUTTER FCRIM103-8HT01

Pressing Clamp Manual



Description	Codes
Pressing clamp manual - large crimper 16-32mm (crimp inserts included) Order QTY:.....	CR-CLAMP FCRIM102-8HT01

Crimp Insert



Description	Codes
Crimp insert (TH profile) 14-32A-16TH Order QTY:.....	CR-INS-16 FCRIM114-8HT01
Crimp insert (TH profile) 14-32A-20TH Order QTY:.....	CR-INS-20 FCRIM115-8HT01
Crimp insert (TH profile) 14-32A-25TH Order QTY:.....	CR-INS-25 FCRIM116-8HT01
Crimp insert (TH profile) 14-32A-32TH Order QTY:.....	CR-INS-32 FCRIM117-8HT01

Spring Internal Bending



Description	Codes
Spring internal bending WH-16 Order QTY:.....	CR-SPRINGINT-16 FCRIM118-8HTO1
Spring internal bending WH-20 Order QTY:.....	CR-SPRINGINT-20 FCRIM120-8HTO1
Spring internal bending WH-25 Order QTY:.....	CR-SPRINGINT-25 FCRIM122-8HTO1
Spring internal bending WH-32 Order QTY:.....	CR-SPRINGINT-32 FCRIM124-8HTO1

Sleeve Stainless Steel



Description	Codes
Sleeve Stainless Steel 16mm x 100 Order QTY:.....	CR-67-16 FCRIM126-8HTO1
Sleeve Stainless Steel 20mm x 100 Order QTY:.....	CR-67-20 FCRIM127-8HTO1
Sleeve Stainless Steel 25mm x 100 Order QTY:.....	CR-67-25 FCRIM128-8HTO1
Sleeve Stainless Steel 32mm x 100 Order QTY:.....	CR-67-32 FCRIM129-8HTO1

Spring External Bending



Description	Codes
Spring external bending WH-16 Order QTY:.....	CR-SPRINGEXT-16 FCRIM119-8HTO1
Spring external bending WH-20 Order QTY:.....	CR-SPRINGEXT-20 FCRIM121-8HTO1
Spring external bending WH-25 Order QTY:.....	CR-SPRINGEXT-25 FCRIM123-8HTO1
Spring external bending WH-32 Order QTY:.....	CR-SPRINGEXT-32 FCRIM125-8HTO1

O-Ring



Description	Codes
O-Ring EPDM 16mm x 200 Order QTY:.....	CR-65-16 FSPROR01-8HTO1
O-Ring EPDM 20mm x 200 Order QTY:.....	CR-65-20 FSPROR02-8HTO1
O-Ring EPDM 25mm x 200 Order QTY:.....	CR-65-25 FSPROR03-8HTO1
O-Ring EPDM 32mm x 200 Order QTY:.....	CR-65-32 FSPROR04-8HTO1

Ball Valve with Butterfly Handle



Description	Codes
Ball valve with butterfly handle 16MMx16MM Order QTY:.....	CR-B/V-16 FCRIM106-8HTO1
Ball valve with butterfly handle 20MMx20MM Order QTY:.....	CR-B/V-20 FCRIM107-8HTO1
Ball valve with butterfly handle 25MMx25MM Order QTY:.....	CR-B/V-25 FCRIM108-8HTO1
Ball valve with butterfly handle 32MMx32MM Order QTY:.....	CR-B/V-32 FCRIM109-8HTO1

Baffle



Description	Codes
Baffle 16mm grey x 100 Order QTY:.....	CR-66-16 FCRIM110-8HTO1
Baffle 20mm grey x 100 Order QTY:.....	CR-66-20 FCRIM111-8HTO1
Baffle 25mm grey x 100 Order QTY:.....	CR-66-25 FCRIM112-8HTO1
Baffle 32mm grey x 100 Order QTY:.....	CR-66-32 FCRIM113-8HTO1

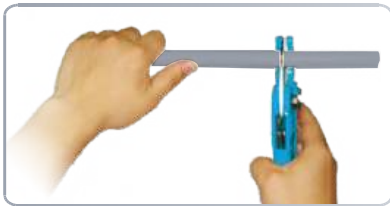

Pipe cutting

Cut the pipe vertically and precisely with a pipe cutter.



Rounding and beveling

Round and bevel the end holes with the Cobra reamer (Plastic reamer or T-reamer).

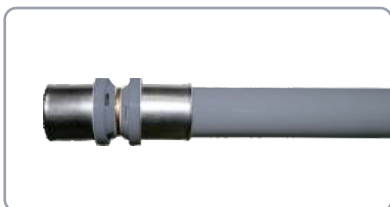

Inserting

Choose the right size sleeved-fitting for the pipe, then aim the pipe end at the inspection holes of corresponding fitting integrated with sleeve and slide the fitting insert into the pipe until it reaches the plastic block.

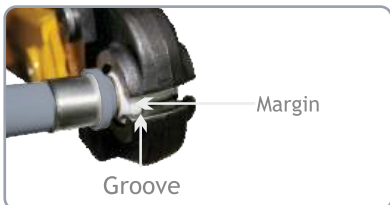

Pressing

Insure the plastic block and sleeve are at the right position in the jaw; The margin of the block must be placed into the groove of the pressing section.



Checking

Release the jaw of the clamping tool when the pressing procedure is complete and inspect the connection.

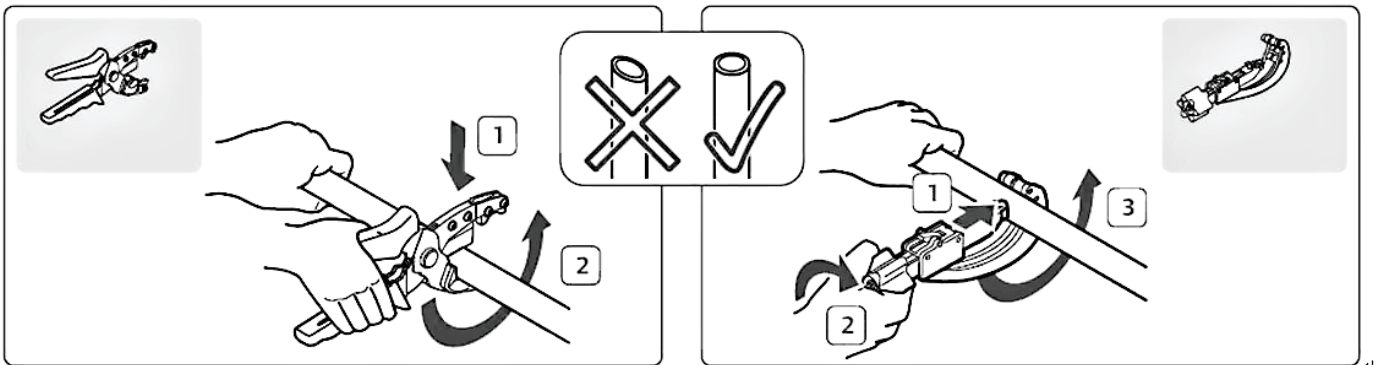

1. Choose the right size fitting according to the pipe size and material. Make sure the installation tools are complete, without any damage before installation.
2. Make sure the cross section is smooth and is not severely at an incline (as shown in the figure above), a severe incline will push the o-ring seal and cause a leak.
3. When beveling the pipe, make sure there are no burrs left on or in the pipe.
4. Insert the pipe horizontally into the fitting.
5. Arrange a pressure test after installing the pipe system, the system installation is qualified if it keeps the pressure for 12 hours at 1500kPa without any leakage.

20 Wright Street,
Factoria,
Krugersdorp, 1739
South Africa

National After Sales Service Number: +27 (0) 861 21 21 21
Customer Helpdesk: customer.helpdesk@lixil.com

ONLINE PLATFORMS

Visit our website and find an
office/dealer/distributor closest to you

Website:

cobra.lixil.co.za

Social Media:

 - @Cobrataps

 - @CobraWatertechSA

Cobra has a policy of continuous product development
and advancements and therefore reserves the right to
modify product specifications accordingly.



PART OF **LIXIL**